

BTL-11.5-85

BI-TELECENTRIC LENSES BY DIOPTIC

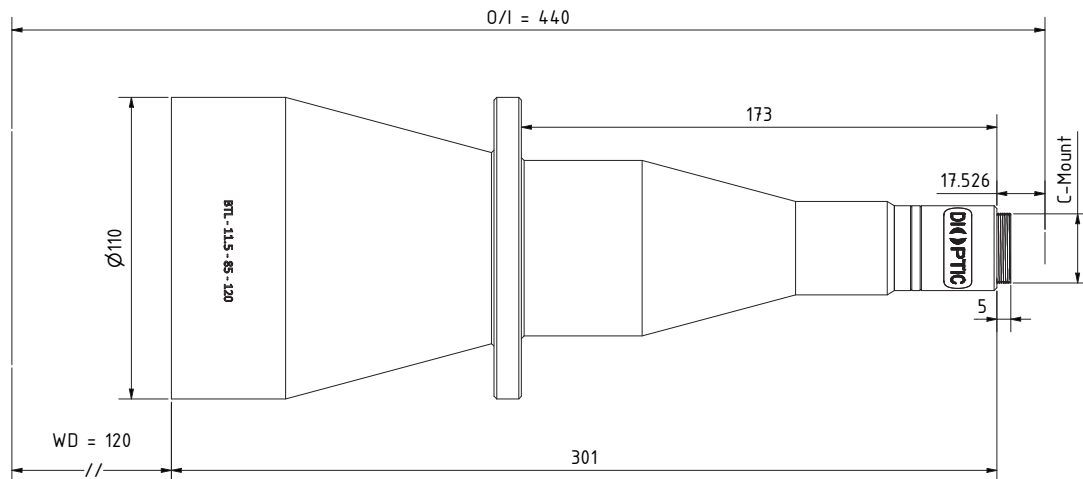

SPECIFICATIONS

Max. Object Circle	85 mm
Max. Image Circle	11.5 mm
Magnification	0.14
Working distance	120 mm
Effective f/#	7.1
Typical MTF at 70 lp/mm	35 %
Typical telecentricity (450 nm, 550 nm, 700 nm)	(0.02°, 0.02°, 0.03°)
Typical distortion	0.04 %
FOV for 2/3" (16.9 mm) Sensor	68.1 mm x 51.1 mm
Mount	C - Mount
Length	306.0 mm
Diameter	110 mm
Weight	1.85 kg
Filter	Available separately