

BTL-18.5-60

BI-TELECENTRIC LENSES BY DIOP TIC

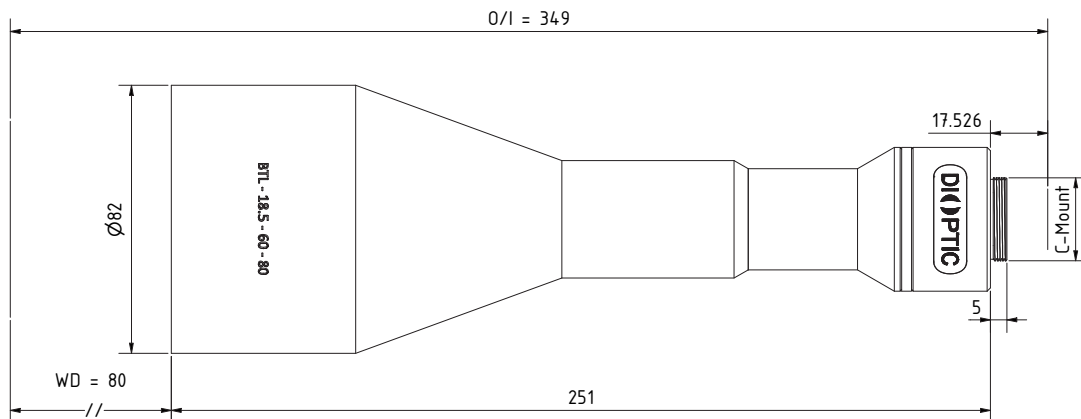

SPECIFICATIONS

Max. Object Circle	60 mm
Max. Image Circle	18.5 mm
Magnification	0.31
Working distance	80 mm
Effective f/#	7.0
Typical MTF at 70 lp/mm	38 %
Typical telecentricity (450 nm, 550 nm, 700 nm)	(0.02°, 0.03°, 0.02°)
Typical distortion	0.02 %
FOV for 1.1" (27.9 mm) Sensor	48.1 mm x 36.0 mm
Mount	C - Mount
Length	254.0 mm
Diameter	82 mm
Weight	1.32 kg
Filter	Available separately