

# BTL-23-60

## BI-TELECENTRIC LENSES BY DIOPTIC

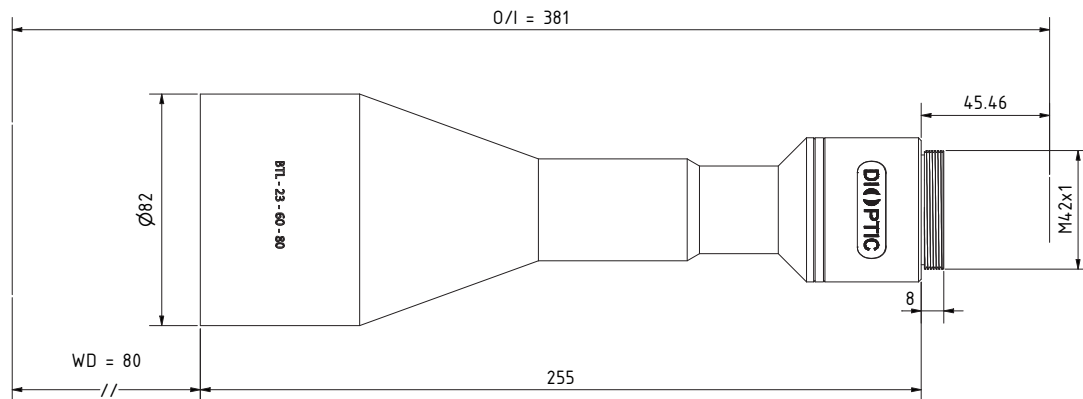

## SPECIFICATIONS

Max. Object Circle	60 mm
Max. Image Circle	23.0 mm
Magnification	0.38
Working distance	80 mm
Effective f/#	7.5
Typical MTF at 70 lp/mm	31 %
Typical telecentricity (450 nm, 550 nm, 700 nm)	(0.02°, 0.03°, 0.03°)
Typical distortion	0.03 %
FOV for 4/3" (33.9 mm) Sensor	48.0 mm x 36.0 mm
Mount	M42
Length	263.0 mm
Diameter	82 mm
Weight	1.43 kg
Filter	Available separately