

BTL-39.2-185

BI-TELECENTRIC LENSES BY DIOPTIC

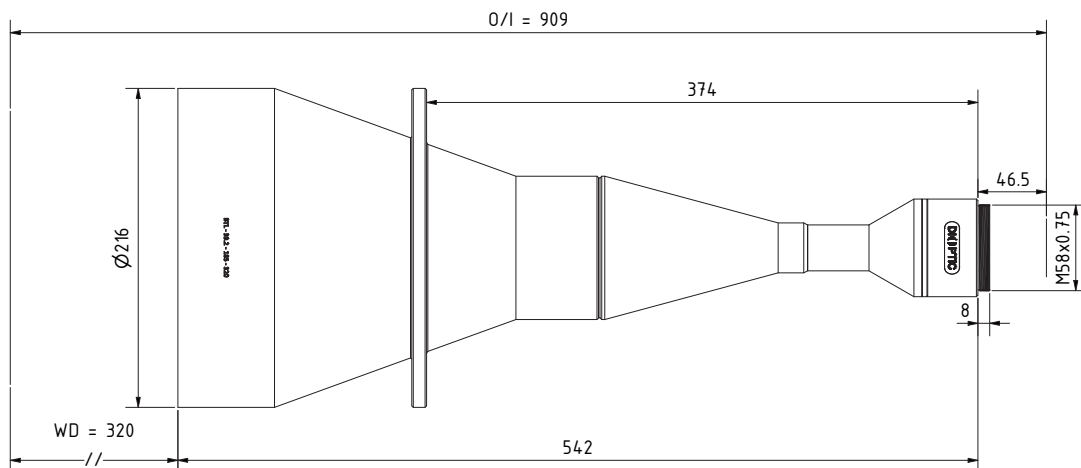

SPECIFICATIONS

Max. Object Circle	185 mm
Max. Image Circle	39.2 mm
Magnification	0.21
Working distance	320 mm
Effective f/#	12.0
Typical MTF at 50 lp/mm	18 %
Typical telecentricity (450 nm, 550 nm, 700 nm)	(0.02°, 0.01°, 0.03°)
Typical distortion	0.06 %
FOV for 39.2 mm Sensor	146.2 mm x 113.7 mm
Mount	M58
Length	549.0 mm
Diameter	216 mm
Weight	13.35 kg
Filter	Available separately