

BTL-39.2-45

BI-TELECENTRIC LENSES BY DIOPTIC

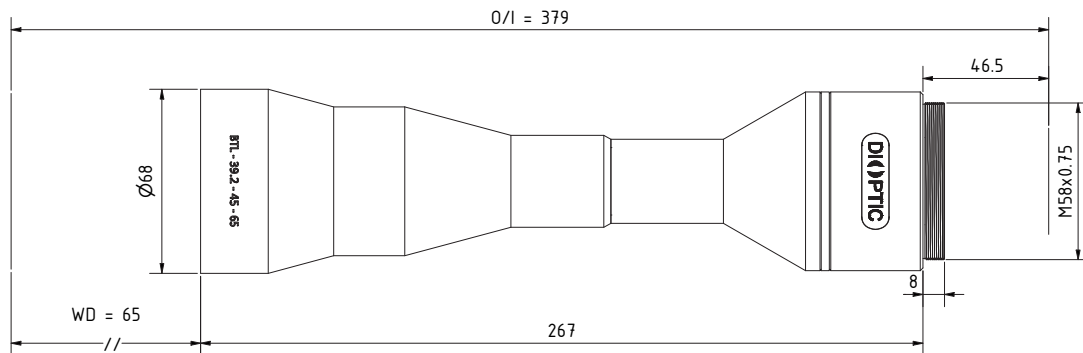

SPECIFICATIONS

Max. Object Circle	45 mm
Max. Image Circle	39.2 mm
Magnification	0.87
Working distance	65 mm
Effective f/#	12.0
Typical MTF at 50 lp/mm	27 %
Typical telecentricity (450 nm, 550 nm, 700 nm)	(0.18°, 0.05°, 0.1°)
Typical distortion	0.04 %
FOV for 39.2 mm Sensor	35.6 mm x 27.7 mm
Mount	M58
Length	255.0 mm
Diameter	66 mm
Weight	1.08 kg
Filter	Available separately