

# BTL-44-85

## BI-TELECENTRIC LENSES BY DIOPTIC

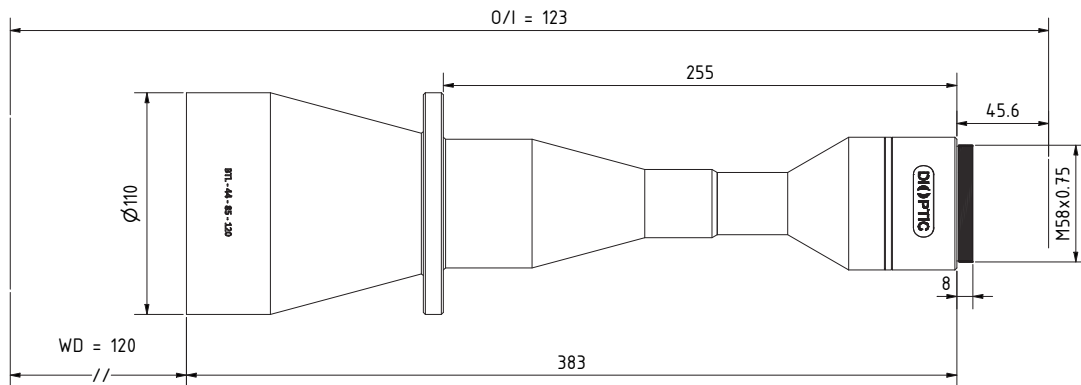

## SPECIFICATIONS

Max. Object Circle	85 mm
Max. Image Circle	44.0 mm
Magnification	0.52
Working distance	120 mm
Effective f/#	13.5
Typical MTF at 50 lp/mm	24 %
Typical telecentricity (450 nm, 550 nm, 700 nm)	(0.02°, 0.02°, 0.03°)
Typical distortion	0.03 %
FOV for 44 mm Sensor	68.0 mm x 51.0 mm
Mount	M58
Length	389.0 mm
Diameter	110 mm
Weight	2.45 kg
Filter	Available separately